



### 1.0 Features

- CMX868A-based socket modem Reference Design
- Fully Isolated 2-Wire Line Interface
- Opto Isolated Ring Detect Circuitry and OptoMOS Hook Relay
- 'AT' Command Compatible Firmware
- On-board FLASH PIC Microcontroller
- PC Controlled via Terminal Emulator
- FCC68 or CTR21 DAA
- Single 3V or 5V dc power supply operation
- Break-off PCB sections
- Supplied with PCB layout data



### 1.1 Brief Description

The DE8681 Demonstration Board is a reference design for the CMX868A V.22 bis modem IC. On the main "socket modem" section it also contains the line interface components and a Flash PIC  $\mu$ C. Attached to the main section are two break-off sections which contain a 9-pin D type socket for PC serial communications, a Flash PIC programming connector, an RJ11 line connector and various LEDs for indicating signal activity. AT Commands are used to control the demonstration board via a standard terminal emulator program running on a host PC.

Interfacing to the Demonstration Board can be via socket pins on the socket modem section, or via the connectors provided on the break-off sections. The board can be operated at 3V or 5V dc, which must be provided by an external, regulated power supply.

The PCB has been laid out for both CTR21 and FCC68 compliant DAA designs. However the components fitted are for the simplified FCC68 design. Instructions are given for users who wish to fit the CTR21 components. Hardware has been provided on the socket modem section for CLI Type 1, but a PIC firmware upgrade will be required to enable this function, which may be available at a later date. With this in mind, the socket modem has been provided with a Flash PIC Microcontroller that can be serially programmed in circuit via the RS232 connection.

<u>Section</u>	<b>CONTENTS</b>	<u>Page</u>
1.0	Features .....	1
1.0	Features .....	1
1.1	Brief Description .....	1
1.2	Preliminary Information.....	4
1.2.1	Equipment.....	4
1.2.2	Handling Precautions .....	4
1.2.3	Approvals.....	4
1.3	Quick Start .....	5
1.3.1	Setting-Up .....	5
1.3.2	Operation .....	5
1.4	Signal Lists .....	7
1.5	Circuit Schematics and Board Layout.....	10
1.6	Detailed Description .....	11
1.6.1	Hardware Description.....	11
1.6.2	Firmware Description .....	12
1.6.3	Software Description .....	23
1.6.4	Additional Information.....	24
1.6.5	Example DE8681 Modem Tests .....	27
1.6.6	Example DE8681 Device Evaluation Tests.....	28
1.6.7	Trouble Shooting .....	30
1.7	Performance Specification.....	31
1.7.1	Electrical Performance .....	31

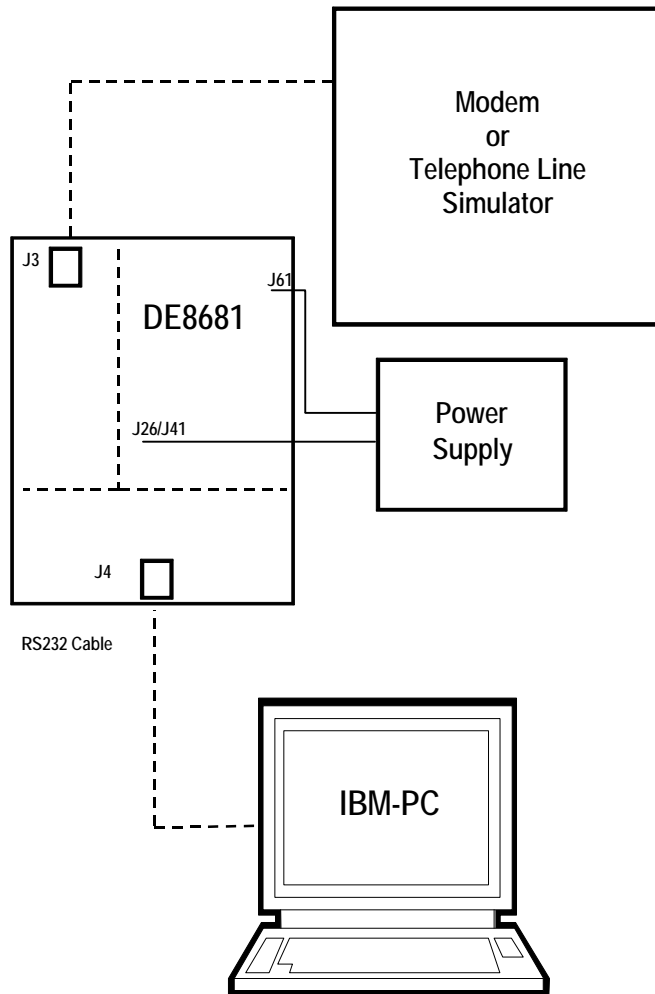

Figure 1 Block Diagram

## **1.2 Preliminary Information**

### **1.2.1 Equipment**

The following equipment is needed to use this demonstration board:

#### **1.2.1.1 3Vdc or 5Vdc Regulated Power Supply**

#### **1.2.1.2 A PC equipped with a serial port running a terminal emulation program such as Microsofts' Hyperterminal.**

#### **1.2.1.3 For PIC re-programming with the CML ESFLASH\_xx.EXE utility, an IBM compatible PC, running Microsoft Windows™ 98, ME, 2000sp4 or XP.**

### **1.2.2 Handling Precautions**

#### **1.2.2.1 Static Protection**

This product uses low power CMOS circuits, which can be damaged by electrostatic discharge. Partially damaged circuits can function erroneously, leading to misleading results. Observe ESD precautions at all times when handling this product.

#### **1.2.2.2 Contents - Unpacking**

Please ensure that you have received all of the items on the separate information sheet (EK8681) and notify CML within 7 working days if the delivery is incomplete.

### **1.2.3 Approvals**

**This product is designed to meet CTR21/FCC68 telecom approval requirements. Users are advised to observe local statutory requirements which may apply to this product before direct or indirect connection to any public telecommunication system.**

## 1.3 Quick Start

This section provides instructions for users who wish to experiment immediately with the demonstration board. A fuller description of the board and its use appears later in this document.

### 1.3.1 Setting-Up

**THE DE8681 COMES PRE-CONFIGURED AS A FCC68 MODEM, USING THE CMX868A TSSOP DEVICE AND A PRE-PROGRAMMED FLASH PIC  $\mu$ C, FOR OPERATION AT 5.0 VOLTS.**

**See section 1.6 for the alternative component values required for 3.0V or CTR21 operation.**

An RJ11 (US style) phone jack, J3, for 2-wire line connection is provided on one of the break-off board sections. Power is connected via socket pins **61(VDD)** and **41(GND)**. See pinout, figure 2.

Attach the 9-way RS232 cable between connector J4 and the serial port of the PC. Connect an external modem/line simulator to the evaluation kit using a suitable RJ11 telephone cable (not supplied).

The DE8681 is supplied with the break-off sections of the board intact. If a socket modem using the industry standard footprint is required, detach these break-off sections from the Demonstration Board PCB by using a suitable tool to scribe along the perforations that join the break-off sections to the main PCB. Scribe on both top and bottom sides of the board and ensure that the scribed line completely cuts any copper tracks entering or leaving the break-off sections from the main PCB. When this is done, gently break-off the first section on which connector J4 (9-pin D Type socket) is mounted, then break-off the second section on which the RJ11 socket is mounted. All connections to the remaining socket modem must now be made through the PCB connector pins.

### 1.3.2 Operation

The DE8681 demonstration board allows the user to perform calling, answering and simple data transfer with a suitable simulator or external third party modem (not supplied).

The board is controlled by the AT command set described in Section 1.6.3, by running a terminal emulator program on the host PC. A suitable emulator is the 'HyperTerminal' program, which operates under Windows 95/NT systems. The DE8681 AT command set consists of Basic, Extended and CML Specific commands.

The board has two modes of operation:

#### **AT Command Mode**

In this mode the command processor firmware is constantly checking to see if the user has typed a valid AT command. When a valid command is received the firmware will execute that command. While the firmware is operating in this mode, the user can instruct it to manually answer a call, originate a call, go on/off hook, read/write to S-registers, issue CML specific AT commands, and perform any number of other AT command functions.

The board always starts in AT Command mode after power is applied and board initialisation is complete.

The CML specific AT commands allow the user to directly control the CMX868A device for evaluation purposes. Note, customer modified CMX868A device registers will be overwritten when Dial and Answer AT commands are executed.

The Dial and Answer commands will execute the relevant DTMF transmit, call progress tone detection and negotiation (handshaking) firmware routines before a connection to a remote modem/simulator can be established. Negotiation may be aborted by pushing any key.

Note, if the S0 register is modified to a non-zero value during this operating mode, the CMX868A status register will be polled every 20ms to check for ring detect status. If valid ringing is detected the DE8681 will automatically answer a call after n ring cycles, where n is equivalent to the contents of the S0 register.

### **Data Transfer Mode**

After gaining a connection (i.e. successful negotiation) with a remote modem the board will be operating in data transfer mode. In this mode the board will transmit all the data it receives from the RS232 computer terminal to the remote modem via the 2-wire line. Likewise any data received from the remote modem via the 2-wire line will be sent to RS232 computer terminal.

Whilst operating in this mode the data stream from the RS232 computer terminal is monitored for the escape code sequence (+++). If this sequence is encountered during data transfer the firmware will revert to on-line AT command mode. Whilst in on-line, AT command mode, the board to remote modem connection may be aborted by typing ATH0 (instructs modem to go on-hook). Alternatively the user can enter relevant AT commands or return to data transfer mode by using the ATO command.

The modem line speed is much lower than the speed of the RS232 interface (RS232 is running at 19200bps) and the DE8681 firmware only provides a small amount of data buffering. Therefore to prevent the data buffer from overflowing the data flow between the  $\mu$ C and RS232 is controlled by the RTS/CTS (Request/Clear to Send) hardware handshake lines.

The CMX868A settings used during negotiation and data transfer will be based on the contents of the S-registers when the call was originated or answered. The S-registers are described in Section 1.6.3. Certain S-register settings (relevant to the CMX868A configuration), modified during on-line AT command mode, will only take effect when a new call is originated or answered. For example, new CMX868A Tx gain settings (S25 register) modified in on-line AT command mode will be ignored until the next call.

## 1.4 Signal Lists

CONNECTOR PINOUT				
Connector Ref.	Connector Pin No.	Signal Name	Signal Type	Description
J1		TIP	Bi	Socket pin - Tip
J2		RING	Bi	Socket pin – Ring
J3	3	RING	Bi	RJ11 connector – Ring
	4	TIP	Bi	RJ11 connector – Tip
J4	1	DCD	Output	9-pin D Type connector – PC DCD
	2	TXD	Output	9-pin D Type connector – PC TXD
	3	RXD	Input	9-pin D Type connector – PC RXD
	4	DTR	Input	9-pin D Type connector – PC DTR
	5	VSS	Power	9-pin D Type connector – PC GND
	6	DSR	Output	9-pin D Type connector - PC DSR
	7	RTS	Input	9-pin D Type connector – PC RTS
	8	CTS	Output	9-pin D Type connector - PC CTS
	9	RI	Output	9-pin D Type connector – PC RI
J5	1	/RESET	Input	1 x 5 header – PIC reset
	2	/CTSTTL	Input	1 x 5 header – PIC programming data
	3	/RTSTTL	Input	1 x 5 header – PIC programming clock
	4	VPP	Power	1 x 5 header – PIC programming voltage
	5	Vss	Power	1 x 5 header Vss connection
J24		/RESET	Input	Socket pin – PIC reset
J26		Vss	Power	Vss connection
J29		DCDIND	Output	Socket pin – DCD LED indication
J30		RXDIND	Output	Socket pin – RXD LED indication
J31		DTRIND	Output	Socket pin – DTR LED indication
J32		TXDIND	Output	Socket pin – TXD LED indication
J33		/RTSTTL	Input	Socket pin – PIC RTS
J34		/RXDTTL	Output	Socket pin – PIC TXD
J35		/TXDTTL	Input	Socket pin – PIC RXD
J36		/RITTTL	Output	Socket pin – PIC RI
J37		/DSRTTL	Output	Socket pin – PIC DSR
J38		/CTSTTL	Output	Socket pin – PIC CTS

<b>CONNECTOR PINOUT</b>				
<b>Connector Ref.</b>	<b>Connector Pin No.</b>	<b>Signal Name</b>	<b>Signal Type</b>	<b>Description</b>
J39		/DCDTTL	Output	Socket pin – PIC DCD
J40		/DTRTTL	Input	Socket pin – PIC DTR
J41		Vss	Power	Vss connection
J61		VDD	Power	+ve power from external power supply
J63		AVss	Power	Analogue Vss connection – Not used

<b>LEDs</b>	
<b>LED Ref.</b>	<b>Description</b>
D7	Illuminated when the line is in an off-hook state
D8	Illuminated when a carrier is detected at the remote modem end of the line
D9	Illuminated when the Socket Modem (DCE) is transmitting data to a host (DTE)
D10	Illuminated when the Socket Modem is receiving data from a host
D11	Illuminated when Data Terminal Ready is asserted by the host system.

<b>JUMPERS</b>			
<b>Jumper Ref.</b>	<b>Positions</b>	<b>Default Position</b>	<b>Description</b>
JP1	1 - 2	S/C	Receiver enable (U8)

**Notes:** Bi = Bidirectional  
S/C = Short Circuit



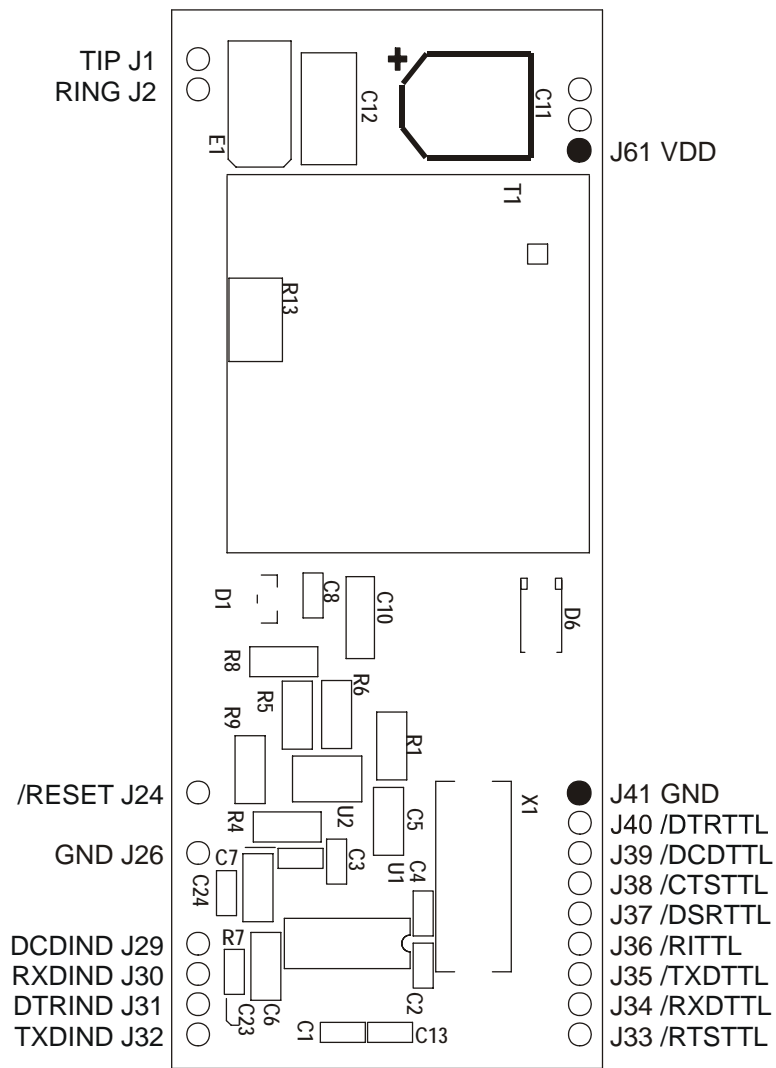

Figure 2, socket section pinout.

Users with a revision B board, PCB024B, must note that the polarity for C11 shown on the silk screen is incorrect. Figures 2 and 5 of this document show corrected polarity.

## 1.5 Circuit Schematics and Board Layout

For clarity, circuit schematics are available as a separate high resolution pdf file. This can be found on the CML website.

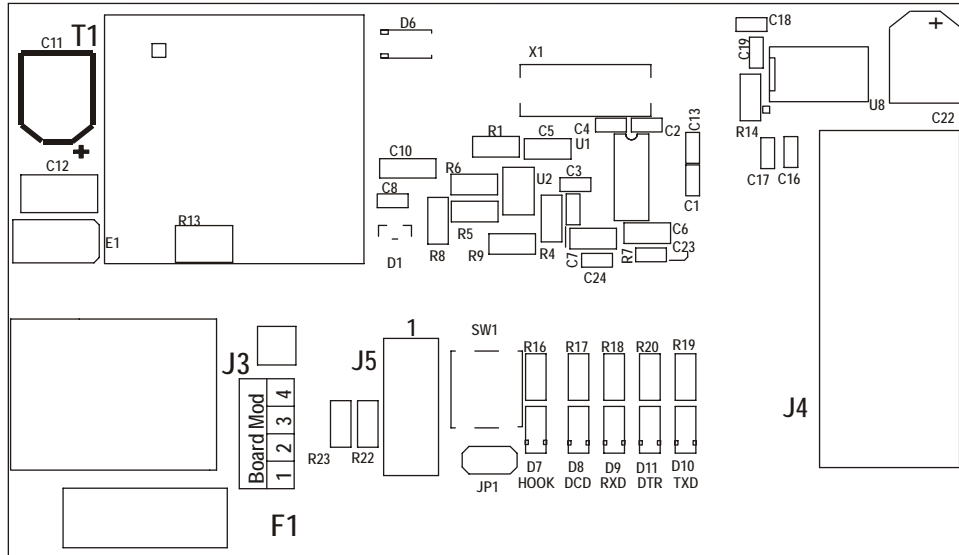

Figure 3 DE8681 top silk screen

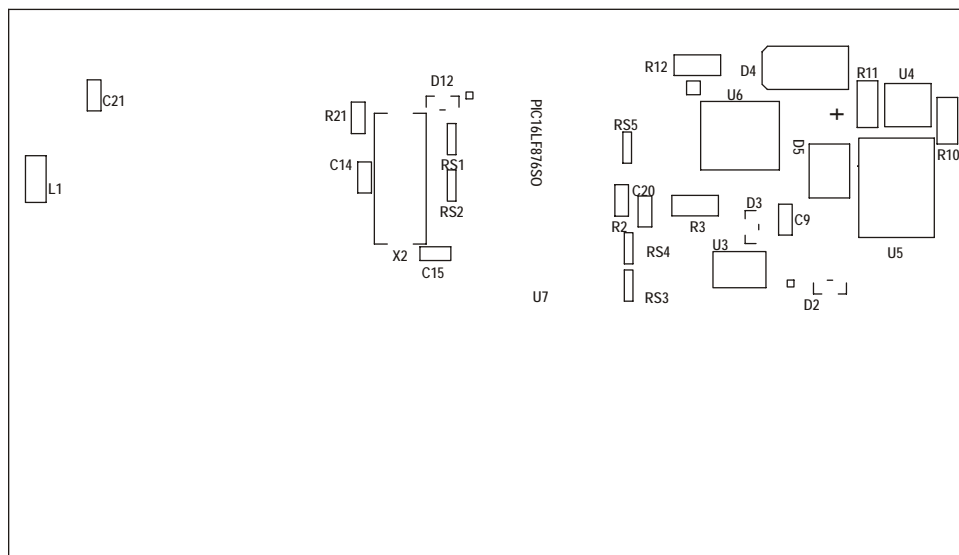

Figure 4 DE8681 bottom silk screen

## 1.6 Detailed Description

### 1.6.1 Hardware Description

#### 1.6.1.1 Operating Voltage

The DE8681 can be operated at a VDD of 3 or 5Vdc (default), supplied by an external regulated power supply. Tables of component values for CTR21 and FCC68 DAAs are shown below:

CTR21 DAA					
VDD	R6	R7	C24	R12	D1
3.0 V	91K (93.5K)	160K	180pF	220R	3.0V
5.0 V	56K (57.6K)	180K	220pF	620R	4.3V

FCC68 DAA					
VDD	R6	R7	C24	R12	D1
3.0 V	100K (107K)	160K	39pF	220R	3.0V
5.0 V	62K (64.9K)	180K	47pF	620R	4.3V

(The values shown in brackets are optimal values)

#### 1.6.1.2 Clock/Oscillator

The CMX868A is clocked at a frequency of 11.0592MHz, which is provided by crystal X1. The PIC  $\mu$ C is clocked with a 4MHz crystal, X2. PIC microcontrollers programmed by CML are only configured for use with the on-board 4MHz crystal.

#### 1.6.1.3 On-hook Caller ID

This function provides a high impedance, on-hook AC path for the routing of Caller ID signals to the CMX868A. Components C9, R5 and U2 provide this transmission path. C9 bypasses the optoMOS relay hook switch, allowing AC signals to pass through T1 when the Socket Modem is in an on-hook state. To compensate for losses incurred in the on-hook state, U2 and R5 increase the receive gain of the CMX868A.

#### 1.6.1.4 Simplified FCC68 Compliant DAA, as Shipped

The values of R4, R6, R7, R8, R9, C8 and C24 are optimal values with respect to the Midcom 82111 transformer. Parts C10 and D4 are not required for this simplified design but are replaced with 0 $\Omega$  links.

#### 1.6.1.5 CTR21 Compliant DAA

Components R10, R11, C11, D4, D5, U4 and U5 may be fitted to provide a 60mA current limit required by CTR21. **Users with a revision B board, PCB024B, must note that the polarity for C11 shown on the silk screen is incorrect. Figures 2 and 5 of this document show corrected polarity.**

An alternative transformer, the Midcom 82107, must be fitted. Parts C10, C24, and R6 also have different values, to match the characteristics of the 82107 transformer and the CTR21 reference impedance. To be compliant with the CTR21 DTMF twist requirement, users must set S-register S28 bits 2-0 to 4. Please note that this will only be effective on DE8681 boards with a board mod state of 2 or higher, boards with a board mod state of 1 cannot meet the CTR21 DTMF twist requirement.

### 1.6.1.6 Line Protection

Line protection is provided by the Sidactor component E1. Sidactor is the trade name for a type of Transient Voltage Suppressor (TVS) manufactured by Teccor Electronics.

### 1.6.1.7 Ring Detection

The ring detect threshold is approximately 20VRMS.

## 1.6.2 Firmware Description

The PIC16LF876-04/SP  $\mu$ C fitted on the DE8681 demonstration board has been programmed by CML before shipment with the latest version of firmware. Please read the separate information sheet (EK8681) and check the CML web site for firmware status. The latest source code and programming file (EF8681xx.HEX, where xx represents the version number) can be downloaded from the CML web site.

The serial communications firmware supplied in the PIC  $\mu$ C assumes the following configuration: 8 data bits, no parity, 1 stop bit and 19,200 baud with hardware flow control.

The firmware routine run at start-up and reset performs the following important tasks:

- Peripheral Interrupt Initialisation
- $\mu$ C ports and I/O direction initialisation
- Serial Communication Interface (SCI) initialisation
- Serial Peripheral Interface (SPI) initialisation
- Loads factory profile 0
- Resets CMX868A device.

The message EF8681 Vx.x, will be displayed in the terminal emulator window when these tasks have been completed.

Note, the CMX868A device is always reset and powered up at the beginning of the negotiation.

The firmware only supports DTMF dialling.

AT command echoing is an option available in the firmware and involves echoing the received characters sent by the PC. The firmware also provides the option of sending result codes to the PC. These responses can be in either an alpha or numeric form.

The AT command set for the DE8681 is tabulated below. These commands can be entered on a PC running Windows terminal emulator software, such as the 'HyperTerminal' program supplied with Windows 95/NT systems.

The 'HyperTerminal' Send Text File facility is useful for data transfer i.e. when the DE8681 has established a connection with a remote modem. This terminal emulator facility can also be used for sending AT command scripts to the DE8681. These scripts should consist of a single line multiple AT command, for example.

[ATH1@RE0=4929@RE6?@RE1=4567<CR>](#)

## **Basic DE8681 AT Commands**

<b>Command</b>	<b>Description</b>
<b>A</b>	<p><b>Answer Command</b> The modem will go off-hook and attempt to establish a connection with a remote modem.</p> <p>Syntax: <b>ATA&lt;CR&gt;</b></p>
<b>A/</b>	<p><b>Re-Execute Previous Command Line</b> Re-executes the last issued command line. This command does not require the AT prefix or a carriage return.</p> <p>Syntax: <b>A/</b></p>
<b>Bn</b>	<p><b>Select Communications Standard</b> Selects the communications standard specified by the parameter n.</p> <p>Syntax: <b>ATBn&lt;CR&gt;</b></p> <p><b>Modifier Usage</b>  <b>n=0</b> Selects ITU-T V.22bis at 2400bps QAM (default).  <b>n=1</b> Selects ITU-T V.22 at 1200bps DPSK.  <b>n=2</b> Selects ITU-T V.23 with Tx 75bps and Rx 1200bps FSK.  <b>n=3</b> Selects ITU-T V.23 with Tx 1200bps and Rx 75bps FSK.  <b>n=4</b> Selects ITU-T V.22 at 600bps DPSK.  <b>n=5</b> Selects ITU-T V.21 at 300bps FSK.  <b>n=6</b> Selects Bell 212A at 1200bps DPSK.  <b>n=7</b> Selects Bell 202 with Tx 150bps and Rx 1200bps FSK.  <b>n=8</b> Selects Bell 202 with Tx 1200bps and Rx 150bps FSK.  <b>n=9</b> Selects Bell 103 at 300bps FSK.</p>
<b>Dn</b>	<p><b>Dial Command</b> This command directs the modem to go off-hook, dials according to the string entered and attempts to establish a connection with a remote modem. The n represents an ASCII string composed of dial digits and dial modifiers and must not exceed the 15 character buffer limit. The DTMF tone dialling digits include 0 through 9, A, B, C, D, and the symbols # and *.</p> <p>For example: <b>ATD9,01621875500&lt;CR&gt;</b></p> <p><b>Modifier Usage</b>  <b>n=L</b> Re-dial last number.  <b>n=,</b> Delay dial sequence (pause setting contained in S-Register S8).</p>
<b>En</b>	<p><b>Echo Command Characters</b></p> <p>Syntax: <b>ATEn&lt;CR&gt;</b></p> <p><b>Modifier Usage</b>  <b>n=0</b> Disables the echoing of commands to the screen.  <b>n=1</b> Enables echoing of commands to the screen (default).</p>

<b>Command</b>	<b>Description</b>
<b>Hn</b>	<p><b>Switch Hook Control</b></p> <p>Syntax: <b>ATHn</b>&lt;CR&gt;</p> <p><b>Modifier Usage</b>  <b>n=0</b> Instructs the modem to go on-hook (disconnect).  <b>n=1</b> Instructs the modem to go off-hook.</p>
<b>In</b>	<p><b>Identification</b></p> <p>Requests the modem to return its product identification information.</p> <p>Syntax: <b>ATIn</b>&lt;CR&gt;</p> <p><b>Modifier Usage</b>  <b>n=0</b> Displays the firmware name and version number.  <b>n=1</b> Displays Product Name.  <b>n=2</b> Displays CML UK sales information.  <b>n=3</b> Displays South East Asia sales information.  <b>n=4</b> Displays NAFTA sales information.</p>
<b>Nn</b>	<p><b>Modulation Fallback Option</b></p> <p>Syntax: <b>ATNn</b>&lt;CR&gt;</p> <p><b>Modifier Usage</b>  <b>n=0</b> When originating or answering, modem negotiates only at the specified communications standard (default).  <b>n=1</b> When originating or answering, falls back from V.22bis to V.22 as required.</p>
<b>O</b>	<p><b>Return to Data Transfer Mode</b></p> <p>Used during on-line AT command mode, this command allows the user to return to data transfer mode. Note, this command does not initiate any retrain sequence.</p> <p>Syntax: <b>ATO</b>&lt;CR&gt;</p>
<b>Qn</b>	<p><b>Enable/Disable Modem Responses</b></p> <p>Syntax: <b>ATQn</b>&lt;CR&gt;</p> <p><b>Modifier Usage</b>  <b>n=0</b> Enables result codes to be issued to the screen (default).  <b>n=1</b> Disables result codes to be issued to the screen.</p>
<b>Sn?</b>	<p><b>S-Register Read</b></p> <p>Command for displaying the contents of an S-Register (See S-Register Table).</p> <p>Syntax: <b>ATSn?</b>&lt;CR&gt;</p> <p>where <b>n</b> is the S-Register to be interrogated (decimal).  Value returned is either in decimal (default) or hex format depending on the setting of Bit 4 in the S14 register.</p>

<b>Command</b>	<b>Description</b>
<b>Sn=x</b>	<p><b>S-Register Write</b> Command for writing to an S-Register (See S-Register Table).</p> <p>Syntax: <b>ATSn=x&lt;CR&gt;</b></p> <p>where <b>n</b> is the S-Register (decimal) and <b>x</b> is the value to be written (decimal, 0-255).</p>
<b>Vn</b>	<p><b>Result Code Format</b></p> <p>Syntax: <b>ATVn&lt;CR&gt;</b></p> <p><b>Modifier Usage</b>  <b>n=0</b> Instructs the modem to display result codes as numbers.  <b>n=1</b> Instructs the modem to display result codes as words (default).</p>
<b>Xn</b>	<p><b>Calling Characteristics</b> Determines which set of responses and calling characteristics are used.</p> <p>Syntax: <b>ATXn&lt;CR&gt;</b></p> <p><b>Modifier Usage</b>  <b>n=0</b> The modem will ignore dial tones and busy tones. Dial tone wait time is zero, and blind dialling is enabled. The modem returns a CONNECT result code when a connection is established.  <b>n=1</b> The modem will ignore dial tones and busy tones. Dial tone wait time is zero, and blind dialling is enabled. The modem returns a CONNECT xxxx result code when a connection is established, where xxxx is the Tx/Rx line speed (default).  <b>n=2</b> The modem will ignore busy tones, but waits for a dial tone before dialling. If a dial tone is not detected within 5 seconds, a NO DIAL TONE result code is returned. The modem returns a CONNECT xxxx result code when a connection is established, where xxxx is the Tx/Rx line speed.  <b>n=3</b> The modem will ignore dial tones. If a busy tone is detected, a BUSY result code is returned. Blind dialling is enabled. The modem returns a CONNECT xxxx result code when a connection is established, where xxxx is the Tx/Rx line speed.  <b>n=4</b> If a dial tone is not detected within 5 seconds, a NO DIAL TONE result code is returned. If a busy tone is detected, a BUSY result code is returned. The modem returns a CONNECT xxxx result code when a connection is established, where xxxx is the Tx/Rx line speed.</p>
<b>Zn</b>	<p><b>Modem Reset</b> Instructs the modem to reset the evaluation device and then reload the factory S-Register settings (See S-Register Table).</p> <p>Syntax: <b>ATZn&lt;CR&gt;</b></p> <p><b>Modifier Usage</b>  <b>n=0</b> Reset CMX868A device and restore factory profile 0.  <b>n=1</b> Reset CMX868A device and restore factory profile 1.</p>

## Extended DE8681 AT Commands

<b>Command</b>	<b>Description</b>
<b>&amp;Fn</b>	<b>Recall Factory Defaults</b> Instructs the modem to reload the factory S-Register settings (See S-Register Table).  Syntax: <b>AT&amp;Fn&lt;CR&gt;</b>  <b>Modifier Usage</b> <b>n=0</b> Recalls factory profile 0. <b>n=1</b> Recalls factory profile 1.
<b>&amp;Gn</b>	<b>Guard Tone Select</b> Selects the Guard tone to be transmitted with highband QAM or DPSK.  Syntax: <b>AT&amp;Gn&lt;CR&gt;</b>  <b>Modifier Usage</b> <b>n=0</b> Disable guard tone (default). <b>n=1</b> Enable 550Hz guard tone. <b>n=2</b> Enable 1800Hz guard tone.

## CML Specific DE8681 AT Commands

<b>Command</b>	<b>Description</b>
<b>@Fn</b>	<b>Test Functions</b>  Syntax: <b>AT@Fn&lt;CR&gt;</b>  <b>Modifier Usage</b> <b>n=0</b> Reserved. <b>n=1</b> Reserved. <b>n=2</b> Delay 100ms. <b>n=3</b> Delay 1s. <b>n=4</b> Initiate BERT as Rx End. <b>(Disabled for EF8681 Version 1.0 Firmware)</b> <b>n=5</b> Initiate BERT as Rx End. <b>(Disabled for EF8681 Version 1.0 Firmware)</b> <b>n=6</b> CMX868A Status Register Monitor Function 1. Continuously reads and displays the contents of the Status register. The update rate is based on the S19 register setting. The function may be aborted by pushing any key. <b>n=7</b> CMX868A Status Register Monitor Function 2. Reads and displays the contents of the Status register when an interrupt occurs. Error message returned after 30 seconds if IRQN does not go low. User must enable IRQN output and set the appropriate IRQ Mask bit before executing this test command. <b>n=8</b> Reserved. <b>n=9</b> Reserved.



<b>Command</b>	<b>Description</b>
<b>@D</b>	<b>DTMF Transmit (Only available on boards with a board mod state of 2 or higher)</b> CMX868A will constantly transmit a selected DTMF tone dialling digit.  Syntax: <b>AT@D&lt;CR&gt;nn..nX</b>  <b>Modifier Usage</b> <b>n = 0-9, A, B, C, D, * or #</b> The DTMF dialling digit to be transmitted. <b>X = any other key</b> Terminates the function.
<b>@RR</b>	<b>CMX868A Device Reset</b> Sends the General Reset Command to the CMX868A device.  Syntax: <b>AT@RR&lt;CR&gt;</b>
<b>@Rn?</b>	<b>CMX868A Register Read</b> Command for displaying the contents of a CMX868A device register  Syntax: <b>AT@Rn?&lt;CR&gt;</b>  where <b>n</b> is a valid CMX868A register address (hexadecimal). Value returned is either in decimal (default) or hex format depending on the setting of Bit 4 in the S14 register.
<b>@Rn=x</b>	<b>CMX868A Register Write</b> Command for writing to a CMX868A device register.  Syntax: <b>AT@Rn=x&lt;CR&gt;</b>  where <b>n</b> is a valid CMX868A register address (hexadecimal) and <b>x</b> is the value to be written (decimal). 8-bit register values should be between 0-255, whilst 16-bit register values should be between 0-65535.

**S-Registers**

The following table gives a brief description of the available S-registers and their functions. Register range, units and factory profiles are also listed.

<b>S-Register</b>				<b>Factory Profiles</b>	
<b>Reg</b>	<b>Range</b>	<b>Units</b>	<b>Description</b>	<b>'0' (Default at Power up)</b>	<b>'1'</b>
<b>S0</b>	0-255	Rings	<b>Automatic answer</b> - Number of rings until automatic answer. If the register is zero the modem will not automatically answer.	0	5
<b>S1</b>	0-255	Rings	<b>Count incoming rings</b> - This register is read only and contains the number of rings detected by the modem.	0	0
<b>S2</b>	0-127	ASCII Decimal	<b>Escape character value</b> - This register defines an ASCII decimal value of the escape character. The default setting is an ASCII + and the escape sequence is +++. A value over 127 disables the escape sequence.	43	43
<b>S3</b>	0-127	ASCII Decimal	<b>Carriage return character</b> - Contains the ASCII decimal value of the character recognised as the command line terminator. This character will also be sent at the end of result codes.	13	13
<b>S4</b>	0-127	ASCII Decimal	<b>Line feed character</b> - Contains the ASCII decimal value of the character recognised by the modem as the line feed. The modem sends the line feed character after a carriage return only when word responses are sent.	10	10
<b>S5</b>	0-127	ASCII Decimal	<b>Backspace character</b> - Contains the ASCII decimal value of the character recognised as a backspace.	8	8
<b>S6</b>	2-255	s	<b>Wait time for blind dialling</b> - Sets the length of time to pause after the modem goes off the hook before the modem dials the first digit of the telephone number.	2	2
<b>S7</b>	1-255	s	<b>Wait for carrier after dial</b> - Sets the length of time the modem waits for a carrier before returning on-hook.	50	50

<b>S-Register</b>				<b>Factory Profiles</b>	
<b>Reg</b>	<b>Range</b>	<b>Units</b>	<b>Description</b>	<b>'0' (Default at Power up)</b>	<b>'1'</b>
<b>S8</b>	0-255	s	<b>Pause Time for Comma Dial Modifier</b> - Specifies the number of seconds to pause for each comma (,) encountered in a dial string.	2	2
<b>S9</b>	1-255	100ms	<b>Reserved</b>	6	6
<b>S10</b>	1-255	100ms	<b>Lost carrier to hang up delay</b> - Sets the length of time that the modem waits before hanging up after the loss of a carrier. This allows the modem to distinguish between disturbances that momentarily break the connection and the remote modem hanging up.	7	7
<b>S11</b>	5-25	10ms	<b>DTMF tone duration</b> - Defines the duration of DTMF tones for tone dialling. The length of pause between each DTMF tone is the same as this duration time.	10	20
<b>S12</b>	0-255	50ms	<b>Escape code guard time</b> - Specifies the minimum time before entry of the escape sequence. This value also dictates the acceptable entry speed (inter-character time) for each escape character.	20	20
<b>S13</b>	0-255	Decimal	<b>Reserved</b>	0	0
<b>S14</b>	0-255	Decimal	<b>General options</b> - provides the following functions: Bit 0 - Reserved Bit 1 - Echo command character, 0 Disables echoing (ATE0), 1 Enables echoing (ATE1) Bit 2 - Result code display, 0 Send responses (ATQ0), 1 Do not send responses (ATQ1) Bit 3 - Word or number responses, 0 Send number responses (ATV0), 1 Send word responses (ATV1) Bit 4 - Output format when reading CMX868A registers or S-registers, 0 Decimal, 1 Hex Bit 5, 6 - Reserved Bit 7 - Answer/originate operation, 0 Answer (ATA), 1 Originate (ATD)	138	128
<b>S15</b>	0-255	Decimal	<b>Reserved</b>	0	0
<b>S16</b>	0-255	Decimal	<b>Reserved</b>	0	0
<b>S17</b>	0-255	Decimal	<b>Reserved</b>	0	0

<b>S-Register</b>				<b>Factory Profiles</b>	
<b>Reg</b>	<b>Range</b>	<b>Units</b>	<b>Description</b>	<b>'0'</b>	<b>'1'</b>
<b>S18</b>	0-255	s	<b>General Purpose Timer</b> - Used for various firmware functions.	30	30
<b>S19</b>	0-255	10ms	<b>General Purpose Timer</b> – Used for various firmware functions	2	2
<b>S20</b>	0-255	Decimal	<b>Reserved</b>	0	0
<b>S21</b>	0-255	Decimal	<b>BERT functions disabled for EF8681 Version 1.0 firmware.</b>  <b>BERT options</b> - Provides the following functions: Bit 0 - BERT End, 0 Rx Board (AT@F4), 1 Tx Board (AT@F5) Bit 1 - BERT Operating Band (ignored for V23/Bell202 BERT operation), 0 Low, 1 High Bit 2, 3, 4, 5 - Reserved Bit 6,7 - BERT Scrambler/Descrambler, 11 Enabled (64 ones detect circuit enabled), 10 Enabled (64 ones detect circuit disabled), 00 Disabled	193	193
<b>S22</b>	0-255	Decimal	<b>Bit Mapped register</b> - Provides the following functions: Bit 0, 1, 2, 3, 4 - Reserved Bit 5, 6, 7 - Calling Characteristics, 000 (ATX0), 100 (ATX1), 101 (ATX2), 110 (ATX3), 111 (ATX4)	0	0
<b>S23</b>	0-255	Decimal	<b>Bit Mapped register</b> - Provides the following functions: Bit 0, 1, 2, 3, 4, 5 - Reserved Bit 6, 7 - Guard Tones (DPSK/QAM high band operation only), 00 None (AT&G0), 11 550Hz (AT&G1), 10 1800Hz (AT&G2)	0	0
<b>S24</b>	0-255	Decimal	<b>Bit Mapped register</b> - Provides the following functions: Bit 0 - CMX868A Xtal Freq, 0 12.2880MHz, 1 11.0592MHz Bit 1 - CMX868A Tx and Rx Fixed Compromise Equalisers (used during negotiation and data transfer), 0 Enable, 1 Disable Bit 2 - CMX868A Auto Equaliser (DPSK operating modes, always enabled during V22bis QAM operation), 0 Disable, 1 Enable Bit 3, 4, 5, 6, 7 – Reserved	1	3

<b>S-Register</b>				<b>Factory Profiles</b>	
<b>Reg</b>	<b>Range</b>	<b>Units</b>	<b>Description</b>	<b>'0'</b>	<b>'1'</b>
<b>S25</b>	0-255	Decimal	<p><b>Bit Mapped register</b> - Provides the following functions:</p> <p>Bit 0, 1, 2 - CMX868A Tx Gain (used during negotiation, data transfer and BERT), 111 0dB, 110 -1.5dB, 101 -3.0dB, 100 -4.5dB, 011 -6dB, 010 -7.5dB, 001 -9.0dB, 000 -10.5dB</p> <p>Bit 3, 4, 5 - CMX868A Tx Data/Stop bits (used during data transfer), 111 8/2 bits, 110 8/1 bits, 101 7/2 bits, 100 7/1 bits, 011 6/2 bits, 010 6/1 bits, 001 5/2 bits, 000 5/1 bits</p> <p>Bit 6, 7 - CMX868A Tx Start-stop mode (used during data transfer), 00 Odd parity, 01 Even parity, 10 No parity</p>	176	176
<b>S26</b>	0-255	Decimal	<p><b>Bit Mapped register</b> - Provides the following functions:</p> <p>Bit 0, 1, 2 - CMX868A Rx Gain (used during negotiation, data transfer and BERT), 111 0dB, 110 -1.5dB, 101 -3.0dB, 100 -4.5dB, 011 -6dB, 010 -7.5dB, 001 -9.0dB, 000 -10.5dB</p> <p>Bit 3, 4, 5 - CMX868A Rx Data and Parity bits (used during data transfer), 111 8 data + parity, 110 8 data, 101 7 data + parity, 100 7 data, 011 6 data + parity, 010 6 data, 001 5 data + parity, 000 5 data</p> <p>Bit 6, 7 - CMX868A Rx USART (used during data transfer), 00 2.3% overspeed, 01 1% overspeed, 10 No overspeed</p>	48	176
<b>S27</b>	0-255	Decimal	<p><b>Bit Mapped register</b> - Provides the following functions:</p> <p>Bit 0, 1, 2, 3 - Reserved.</p> <p>Bit 4, 5, 6, 7 - Communication Standard, 0000 (ATB0), 0001 (ATB1), 0010 (ATB2), 0011 (ATB3), 0100 (ATB4), 0101 (ATB5), 0110 (ATB6), 0111 (ATB7), 1000 (ATB8), 1001 (ATB9)</p>	0	0

<b>S-Register</b>				<b>Factory Profiles</b>	
<b>Reg</b>	<b>Range</b>	<b>Units</b>	<b>Description</b>	<b>'0'</b>	<b>'1'</b>
<b>S28</b>	0-255	Decimal	<b>Bit Mapped register</b> – Provides the following functions: Bit 0, 1, 2 – CMX868A DTMF Twist level, 000 +2.0dB, 001 +1.0dB, 010 +1.5dB, 011 +2.5dB, 100 +3.0dB, 101 +3.5dB, 110 +4.0dB, 111 +4.5dB (do not use in conjunction with the 0dB Tx level setting) These DTMF twist settings are only effective on boards with a board mod state of 2 or higher.  Bit 3, 4, 5, 6, 7 - Reserved.	0	0
<b>S29</b>	0-255	Decimal	<b>Reserved</b>	0	0

### Modem Result Codes

#### *Numeric Response (Decimal)*

00

01

02

03

04

05

06

07

08

09

10

11

12

13

14

15

#### *Alpha Response*

OK

CONNECT

RING

NO CARRIER

ERROR

NO DIAL TONE

BUSY

CONNECT 2400

CONNECT 1200

CONNECT 600

CONNECT 300

CONNECT 1200/75

CONNECT 75/1200

CONNECT 1200/150

CONNECT 150/1200

NYI

(Not Yet Implemented)

### AT Command Summary

- 1) The maximum command length is 48 characters, excluding the AT prefix and carriage return.
- 2) A user defined escape sequence (usually +++) is required to revert the modem from on-line (data transfer mode) to the command mode, to allow the user to issue AT commands to the PIC.
- 3) Every command except for A/ and the escape sequence must begin with the AT prefix and be entered by pressing a carriage return.
- 4) When the default command echoing and word result codes are enabled the firmware will send a LF character directly after a CR character to ensure the terminal emulator display is legible.
- 5) Commands which are not fully implemented will return the result code 'NYI' (Not Yet Implemented).
- 6) Do not send AT commands to the Demonstration board until the previous result code (if enabled) has been received.

### 1.6.3 Software Description

#### 1.6.3.1 Terminal Emulator

Users will need to run a suitable terminal emulator on their PC in order to communicate with the PIC  $\mu$ C on the DE8681. 'HyperTerminal', which was supplied with Windows installations, is suitable for this purpose.

##### HyperTerminal Setup

Emulation VT100

ASCII Character set

ASCII Receiving: Wrap lines that exceed terminal width.

COM Port Settings:

Bits per second	19,200
Data bits	8
Parity	None
Stop bits	1
Flow Control	Hardware

#### 1.6.3.2 In Circuit PIC Programming

The software application ESFlash\_xx.exe can be used to program the PIC  $\mu$ C. This tool is available from the CML website in the product resources area. Before programming can commence, set up the board as follows:

Connect a 9-way RS232 cable between connector J4 and a serial port on the PC.

Connect a 5.0Vdc supply across pins **J61 (VDD)** and **J41 (GND)**.

Connect a 12Vdc supply to pins **4(VPP)** and **5(GND)** on connector J5.

Ensure that jumper JP1 is fitted.

Apply both voltages.

Run the ESFlash\_xx.exe application software.

When the CML Flash Programmer dialog is displayed proceed as follows:

Select DE8681 as the Target Type.

Select COM1 or COM2 as the Communications Resource.

Click on Load File button and an Open File dialog will be displayed.

Select the required hex file.

Click on the Options button.

Set the required Target Options and click on the OK button. If the configuration words for the PIC  $\mu$ C are included in the source code, then it is not necessary to manually set the options. The EF8681xx.hex file (where xx represents the version number) that is supplied with the board is built from source code that includes relevant values for the configuration words.

The dialog box should now look like the example one shown in figure 5.

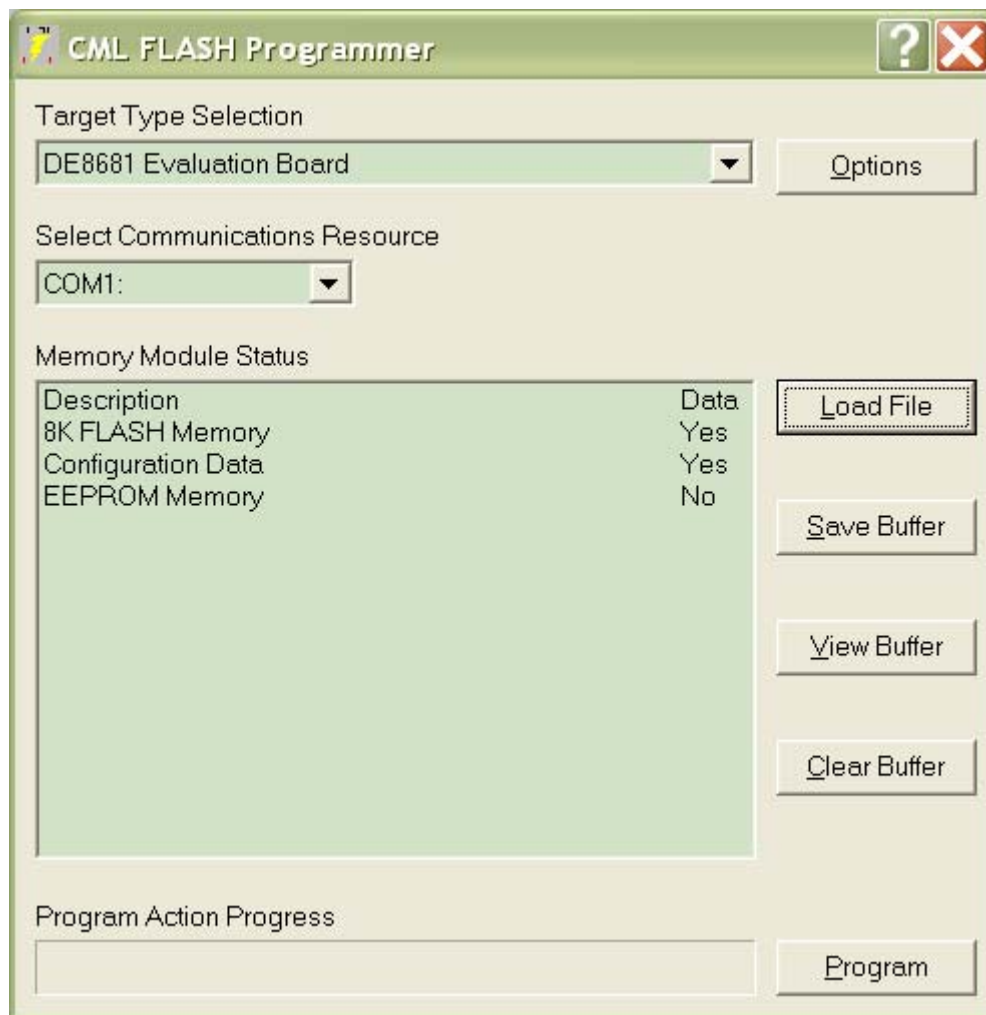

**Figure 5 - CML Flash Programmer dialog box**

Click on the Program button.  
 Press switch SW1 on the DE8681 when requested.  
 Click on the OK button.

After programming has been completed, the 12Vdc supply can be disconnected from connector, J5.

#### 1.6.4 Additional Information

##### 1.6.4.1 AT Command Text Files

To allow evaluation tests to be quickly and easily repeated it may be useful to create text files containing single line multiple AT commands. Commands can be transferred to the PIC  $\mu$ C via the 'HyperTerminal' send text file facility. Note, multiple text files may be required to perform a test if any command lines exceed 48 characters.



### 1.6.4.2 Sending Text Files using 'HyperTerminal'

The following is a description of how to send text files to the DE8681 using 'HyperTerminal'.

- a) Select the Transfer menu
- b) Select Send Text File

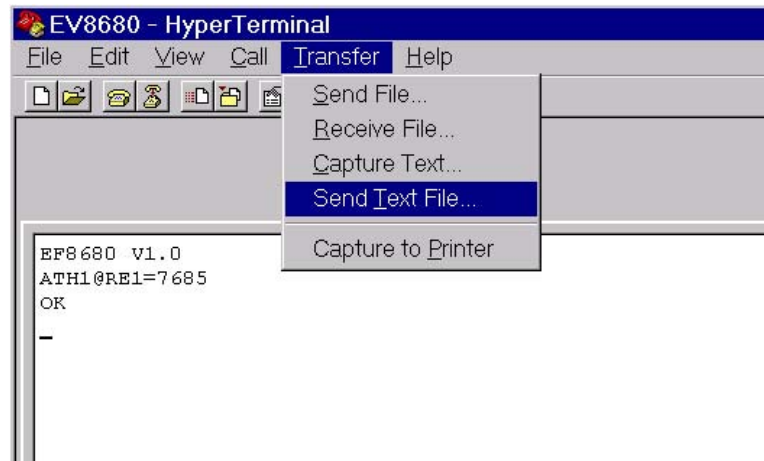

- c) Select the required file from the Send Text File window

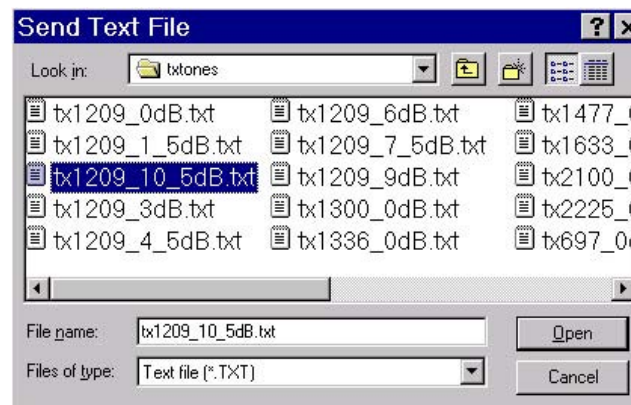

### 1.6.4.3 Negotiation and Data Transfer

Modem negotiation (handshaking) may be aborted by pushing any key prior to entering data transfer mode.

During data transfer mode the user can revert to on-line AT command mode by typing the escape code sequence (+++). The escape code guard time (based on S12) must have expired to successfully access this mode. Whilst in on-line AT command mode the board to remote modem connection may be aborted by typing ATH0 (instructs modem to go on-hook). Alternatively the user can enter relevant AT commands or return to data transfer mode by using the ATO command.

The firmware only supports asynchronous data transfer.

Receiver USART overspeed settings specified in S-Register, S26, only apply to DPSK/QAM operating modes.

Transmitter Guard Tone settings specified in S-Register, S23, only apply to DPSK/QAM answering modes.

If the carrier is lost (during data transfer) or negotiation is aborted by the user, the firmware will send the General Reset Command to the CMX868A device. This action will cause the DE8681 demonstration board to hang up and powersave the CMX868A device.

The data transfer firmware does not contain any retrain code. This process is sometimes performed by modems when signal distortion or line noise is detected which may threaten data integrity.

The receive auto equaliser function can be enabled via the S24 register. This S24 register setting only applies to DPSK modes of operation. The DE8681 firmware for V22bis always enables the receive auto equaliser half way through the negotiation phase.

### 1.6.4.4 Example AT Commands for Hayes Optima 336 Modem (not supplied) Setup

**V.22bis Protocol** - AT&FB30X1Q0E1V1L0N0W2S37=6S95=42

**V.22 Protocol** - AT&FB0X1Q0E1V1L0N0W2S37=5S95=42

## 1.6.5 Example DE8681 Modem Tests

### 1.6.5.1 Set up DE8681 to Automatically Answer a V.22 Call from a Remote Modem

1. Select V.22 communication standard (default is V.22 bis).  
Command : **ATB1<CR>**
2. Select the required Guard Tone setting using the AT&Gn command (default is none).
3. Enable/Disable Fixed Compromise Equalisers by writing to S-Register, S24 (default is enabled).
4. Configure CMX868A Transmitter by writing to S-Register, S25.
5. Configure CMX868A Receiver by writing to S-Register, S26.
6. Set Automatic Answer S-Register (S0) to 5 rings.  
Command : **ATS0=5<CR>**

The DE8681 will attempt to establish a V.22 connection when 5 rings (BT or Bell) have been successfully detected. The CONNECT 1200 result code will be returned to the PC if a V.22 connection is successfully established. The NO CARRIER result code will be returned to the PC if the DE8681 fails to establish a V.22 connection within the time specified in S-Register, S18.

### 1.6.5.2 Set up DE8681 to Manually Answer V.23 Call from a Remote Modem

1. Select V.23 communication standard (default is V.22 bis).  
Command : **ATB2<CR>**
2. Enable/Disable Fixed Compromise Equalisers by writing to S-Register, S24 (default is enabled).
3. Configure CMX868A Transmitter by writing to S-Register, S25
4. Configure CMX868A Receiver by writing to S-Register, S26.
5. Manually Answer V.23 Call.  
Command : **ATA<CR>**

The DE8681 will attempt to establish a V.23 connection. The CONNECT 1200/75 result code will be returned to the PC if a V.23 connection is successfully established. The NO CARRIER result code will be returned to the PC if the DE8681 fails to establish a V.23 connection within the time specified in S-Register, S18.

### 1.6.5.3 Set up DE8681 to Originate V.22 bis Call to a Remote Modem

Configure DE8681 to dial out using a blind dialling method with DTMF tone duration of 150ms.

1. Select V.22 bis communication standard (default is V.22 bis).  
Command : **ATB0<CR>**
2. Set calling characteristic to blind dial, ignoring dial and busy tones (default is ATX1).  
Command : **ATX1<CR>**
3. Set Wait Time for Blind dialling S-Register (S6) to 5 seconds.  
Command : **ATS6=5<CR>**
4. Set DTMF Tone Duration S-Register (S11) to 150ms.  
Command : **ATS11=15<CR>**
5. Enable/Disable Fixed Compromise Equalisers by writing to S-Register, S24 (default is enabled).
6. Configure CMX868A Transmitter by writing to S-Register, S25.
7. Configure CMX868A Receiver by writing to S-Register, S26.
8. DTMF Dial.  
Command : **ATD0165447887<CR>**

The DE8681 will go off-hook and blind dial after 5 seconds. After dialling the DE8681 will attempt to establish a V.22 bis connection. The CONNECT 2400 result code will be returned to the PC if a V.22 bis connection is successfully established. The NO CARRIER result code will be returned to the PC if the DE8681 fails to establish a V.22 bis connection within the time specified in S-Register, S7.

### 1.6.6 Example DE8681 Device Evaluation Tests

The following information shows example text files (not supplied) that can be created by the user for DE8681 Evaluation Mode Tests.

Description : Instructs DE8681 to reset and powerup the CMX868A evaluation device.

Command : **AT@RE0=4480@F2@RE0=4352<CR>**

@RE0=4480 : Load 1180 Hex into CMX868A General Control Register (\$E0)

@F2 : 100ms Delay

@RE0=4352 : Load 1100 Hex into CMX868A General Control Register (\$E0)

General Control Register (\$E0) = 1180 Hex

B15	B14	B13	B12	B11	B10	B9	B8	B7	B6	B5	B4	B3	B2	B1	B0
0	0	0	1	0	0	0	1	1	0	0	0	0	0	0	0
			11.0592 Xtal	No LB	Equ Enable	On Hook	Powered Up	Reset	IRQN O/P Disabled	No IRQ Mask					

General Control Register (\$E0) = 1100 Hex

B15	B14	B13	B12	B11	B10	B9	B8	B7	B6	B5	B4	B3	B2	B1	B0
0	0	0	1	0	0	0	1	0	0	0	0	0	0	0	0
			11.0592 Xtal	No LB	Equ Enable	On Hook	Powered Up	Norm	IRQN O/P Disabled	No IRQ Mask					

The following information shows example AT commands for simple DE8681 demonstration board tests. All tests assume the CMX868A is powered up, as shown above.

### Test 1

Description : Instructs DE8681 to go off-hook and transmit a 1209Hz tone (Tx Gain = 0dB).

Command : **ATH1@RE1=7685<CR>**

H1 : Take DE8681 Off-Hook

@RE1=7685 : Load 1E05 Hex into CMX868A Tx Mode Register (\$E1)

Tx Mode Register (\$E1) = 1E05 Hex

B15	B14	B13	B12	B11	B10	B9	B8	B7	B6	B5	B4	B3	B2	B1	B0
0	0	0	1	1	1	1	0	0	0	0	0	0	1	0	1
Tx Mode = DTMF/Tones				Tx Level = 0dB				Unused				Tx 1209Hz Fixed Tone			

### Test 2

Description : Instructs DE8681 to go off-hook and transmit a 1209Hz tone (Tx Gain = -10.5dB).

Command : **ATH1@RE1=4101<CR>**

H1 : Take DE8681 Off-Hook

@RE1=4101 : Load 1005 Hex into CMX868A Tx Mode Register (\$E1)

Tx Mode Register (\$E1) = 1005 Hex

B15	B14	B13	B12	B11	B10	B9	B8	B7	B6	B5	B4	B3	B2	B1	B0
0	0	0	1	0	0	0	0	0	0	0	0	0	1	0	1
Tx Mode = DTMF/Tones				Tx Level = -10.5dB				Unused				Tx 1209Hz Fixed Tone			

### Test 3

Description : Instructs DE8681 to go off-hook and transmit a 2100Hz tone (Tx Gain = 0dB).

Command : **ATH1@RE1=7690<CR>**

H1 : Take DE8681 Off-Hook

@RE1=7690 : Load 1E0A Hex into CMX868A Tx Mode Register (\$E1)

Tx Mode Register (\$E1) = 1E0A Hex

B15	B14	B13	B12	B11	B10	B9	B8	B7	B6	B5	B4	B3	B2	B1	B0
0	0	0	1	1	1	1	0	0	0	0	0	1	0	1	0
Tx Mode = DTMF/Tones				Tx Level = 0dB				Unused				Tx 2100Hz Fixed Tone			

### Test 4

Description : Instructs DE8681 to go off-hook and transmit V.23 continuous 1s at 75bps.

Command : **ATH1@RE1=19995<CR>**

H1 : Take DE8681 Off-Hook

@RE1=19995 : Load 4E1B Hex into CMX868A Tx Mode Register (\$E1)

Tx Mode Register (\$E1) = 4E1B Hex

B15	B14	B13	B12	B11	B10	B9	B8	B7	B6	B5	B4	B3	B2	B1	B0
0	1	0	0	1	1	1	0	0	0	0	1	1	0	1	1
Tx Mode = V.23 FSK 75 bps				Tx Level = 0dB				No Guard Tone		Scrambler Disabled		Sync Mode		Tx Cont 1's	

## Test 5

Description : Instructs DE8681 to go off-hook and transmit two DTMF digits ('A' then 'B' with 100ms duration/separation).

Command : **ATH1@RE1=7709@F2@RE1=7680@F2@RE1=7710@F2@RE1=7680<CR>**

H1 : Take DE8681 Off-Hook

@F2 : 100ms Delay

@RE1=7709 : Load 1E1D Hex into CMX868A Tx Mode Register (\$E1)

@RE1=7680 : Load 1E00 Hex into CMX868A Tx Mode Register (\$E1)

@RE1=7710 : Load 1E1E Hex into CMX868A Tx Mode Register (\$E1)

Tx Mode Register (\$E1) = 1E1D Hex

B15	B14	B13	B12	B11	B10	B9	B8	B7	B6	B5	B4	B3	B2	B1	B0
0	0	0	1	1	1	1	0	0	0	0	1	1	1	0	1
Tx Mode = DTMF/Tones				Tx Level = 0dB				Unused				Tx DTMF 'A'			

Tx Mode Register (\$E1) = 1E00 Hex

B15	B14	B13	B12	B11	B10	B9	B8	B7	B6	B5	B4	B3	B2	B1	B0
0	0	0	1	1	1	1	0	0	0	0	0	0	0	0	0
Tx Mode = DTMF/Tones				Tx Level = 0dB				Unused				Tx No Tone			

Tx Mode Register (\$E1) = 1E1E Hex

B15	B14	B13	B12	B11	B10	B9	B8	B7	B6	B5	B4	B3	B2	B1	B0
0	0	0	1	1	1	1	0	0	0	0	1	1	1	1	0
Tx Mode = DTMF/Tones				Tx Level = 0dB				Unused				Tx DTMF 'B'			

## Test 6

Description : Set up CMX868A for receiving DTMF, then wait for five DTMF digits.

Command : **AT@RE0=5953@RE2=7681@RE6?@F7@F7@F7@F7@F7<CR>**

@RE0=5953 : Load 1741 Hex into CMX868A General Control Register (\$E0)

@RE2=7681 : Load 1E01 Hex into CMX868A Rx Mode Register (\$E2)

@RE6? : Read and display contents of CMX868A Status Register (\$E6)

@F7 : Wait until IRQN output goes low then read and display contents of CMX868A Status Register (\$E6)

General Control Register (\$E0) = 1741 Hex

B15	B14	B13	B12	B11	B10	B9	B8	B7	B6	B5	B4	B3	B2	B1	B0
0	0	0	1	0	1	1	1	0	1	0	0	0	0	0	1
			11.0592 Xtal	No LB	Equ Disable	Off Hook	Powered Up	Norm	IRQN O/P Enabled	DTMF Detect IRQ Mask					

Rx Mode Register (\$E2) = 1E01 Hex

B15	B14	B13	B12	B11	B10	B9	B8	B7	B6	B5	B4	B3	B2	B1	B0
0	0	0	1	1	1	1	0	0	0	0	0	0	0	0	1
Rx Mode = DTMF/Tones				Rx Level = 0dB				Detect DTMF							

### 1.6.7 Trouble Shooting

Some terminal emulators have been found not to support full hardware flow control when transferring text files. This could result in data loss when using this facility. If this problem is experienced users should try using a different terminal emulator

To ensure successful negotiation and data transfer between the DE8681 and third party modems, users should ensure their third party modem is configured to the correct protocol (see third party AT command documentation).

Note, any sudden loss of the 2-wire line during data transfer will result in loss of carrier and therefore the demonstration board will hang up and display the NO CARRIER message. However, due to the lost carrier to hang up delay (S10), a short burst of corrupt characters (noise generated) will be observed on the HyperTerminal window before the NO CARRIER message is displayed. These corrupt characters can sometimes match control characters and therefore modify HyperTerminal's behaviour. The user is advised to restart HyperTerminal if this happens.

## 1.7 Performance Specification

### 1.7.1 Electrical Performance

#### 1.7.1.1 Absolute Maximum Ratings

Exceeding these maximum ratings can result in damage to the DE8681.

	Min.	Max.	Units
Supply ( $V_{DD} - V_{SS}$ )	-0.3	7.0	V
Voltage on any connector pin to $V_{SS}$	-0.3	$V_{DD} + 0.3$	V
Current into or out of any socket modem connector pin other than $V_{DD}$ , $V_{SS}$ , TIP and RING	-20	+20	mA
Storage Temperature	-40	+125	°C
Operating Temperature	-30	+85	°C

#### 1.7.1.2 Operating Limits

Correct operation of the DE8681 outside these limits is not implied.

	Notes	Min.	Max.	Units
Supply ( $V_{DD} - V_{SS}$ )		2.7	5.5	V
Operating Temperature		+10	+35	°C

#### 1.7.1.3 Operating Characteristics

For the following conditions unless otherwise specified:

Evaluation Device Xtal Frequency = 11.0592MHz  $\pm$ 0.01% (100ppm)  
 $V_{DD}$  = 3.0V or 5.0V,  $T_{amb}$  = +25°C.

	Notes	Min.	Typ.	Max.	Units
<b>DC Parameters</b>					
$I_{DD}$ (socket modem alone - idle)	1		12.0		mA
$I_{DD}$ (demonstration board - idle)	1		30.0		mA

**Notes:** 1. DCD, TXD, RXD, DTR, and HOOK LEDs off.



CML does not assume any responsibility for the use of any circuitry described. No IPR or circuit patent licences are implied. CML reserves the right at any time without notice to change the said circuitry and any part of this product specification. Evaluation kits and demonstration boards are supplied for the sole purpose of demonstrating the operation of CML products and are supplied without warranty. They are intended for use in a laboratory environment only and are not for re-sale, end-use or incorporation into other equipments. Operation of these kits and boards outside a laboratory environment is not permitted within the European Community. All software/firmware is supplied "as is" and is without warranty. It forms part of the product supplied and is licensed for use only with this product, for the purpose of demonstrating the operation of CML products. Whilst all reasonable efforts are made to ensure that software/firmware contained in this product is virus free, CML accepts no responsibility whatsoever for any contamination which results from using this product and the onus for checking that the software/firmware is virus free is placed on the purchaser of this evaluation kit or development board.

[www.cmlmicro.com](http://www.cmlmicro.com)

**For FAQs see:** [www.cmlmicro.com/products/faqs/](http://www.cmlmicro.com/products/faqs/)

**For a full data sheet listing see:** [www.cmlmicro.com/products/datasheets/download.htm](http://www.cmlmicro.com/products/datasheets/download.htm)

**For detailed application notes:** [www.cmlmicro.com/products/applications/](http://www.cmlmicro.com/products/applications/)

 <b>CML Microcircuits (UK) Ltd</b> <small>COMMUNICATION SEMICONDUCTORS</small>	 <b>CML Microcircuits (USA) Inc.</b> <small>COMMUNICATION SEMICONDUCTORS</small>	 <b>CML Microcircuits (Singapore) Pte Ltd</b> <small>COMMUNICATION SEMICONDUCTORS</small>	
Oval Park, Langford, Maldon, Essex, CM9 6WG - England.  Tel: +44 (0)1621 875500 Fax: +44 (0)1621 875600  Sales: <a href="mailto:sales@cmlmicro.com">sales@cmlmicro.com</a>  Technical Support: <a href="mailto:techsupport@cmlmicro.com">techsupport@cmlmicro.com</a>	4800 Bethania Station Road, Winston-Salem, NC 27105 - USA.  Tel: +1 336 744 5050, 800 638 5577 Fax: +1 336 744 5054  Sales: <a href="mailto:us.sales@cmlmicro.com">us.sales@cmlmicro.com</a>  Technical Support: <a href="mailto:us.techsupport@cmlmicro.com">us.techsupport@cmlmicro.com</a>	No 2 Kallang Pudding Road, #09 - 05/06 Mactech Industrial Building, Singapore 349307  Tel: +65 6745 0426 Fax: +65 6745 2917  Sales: <a href="mailto:sg.sales@cmlmicro.com">sg.sales@cmlmicro.com</a>  Technical Support: <a href="mailto:sg.techsupport@cmlmicro.com">sg.techsupport@cmlmicro.com</a>	No. 218, Tian Mu Road West, Tower 1, Unit 1008, Shanghai Kerry Everbright City, Zhabei, Shanghai 200070, China.  Tel: +86 21 6317 4107 +86 21 6317 8916 Fax: +86 21 6317 0243  Sales: <a href="mailto:cn.sales@cmlmicro.com.cn">cn.sales@cmlmicro.com.cn</a>  Technical Support: <a href="mailto:sg.techsupport@cmlmicro.com">sg.techsupport@cmlmicro.com</a>